

Advanced Oil-less Rocking Piston Pumps Series

■ Features ;

- ◆ Oil-less operation & permanently lubricated bearings
- ◆ Provided with high performance silencer
- ◆ **Stainless steel valves and AL Die Casting body**
- ◆ **Completely oil-free & Light weight**
- ◆ Low noise & vibration, leak tight
- ◆ Distinguished long life & easy to maintain
- ◆ **PTFE Coated Model available as Standard**

■ Applications ;

- ◆ Medical, Dental & E.N.T. Equipments
- ◆ **Oxygen Concentrator** & Ozone generator
- ◆ Semi Conductor processing , Chip mounter
- ◆ Packing machine, Food processing
- ◆ Environmental equipments
- ◆ Air Plasma / Laser Cutting Machine
- ◆ Industrial equipments

■ Selection Guide of Model

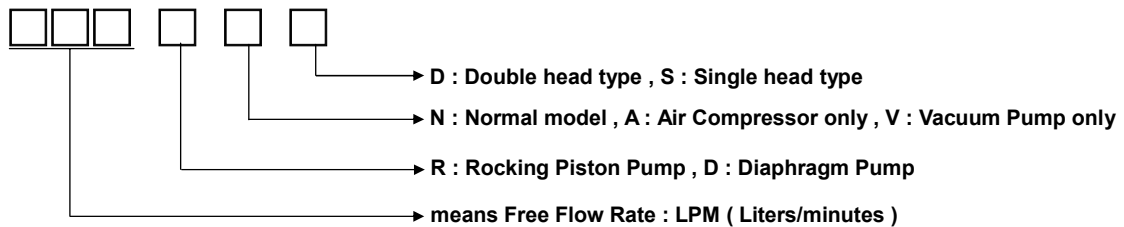

For Example ;

Model : 100RND (Flow : 100LPM , Rocking Piston Pump , Air compressor & Vacuum Pump available , Double Head

■ DIMENSIONS : Unit in Millimeters

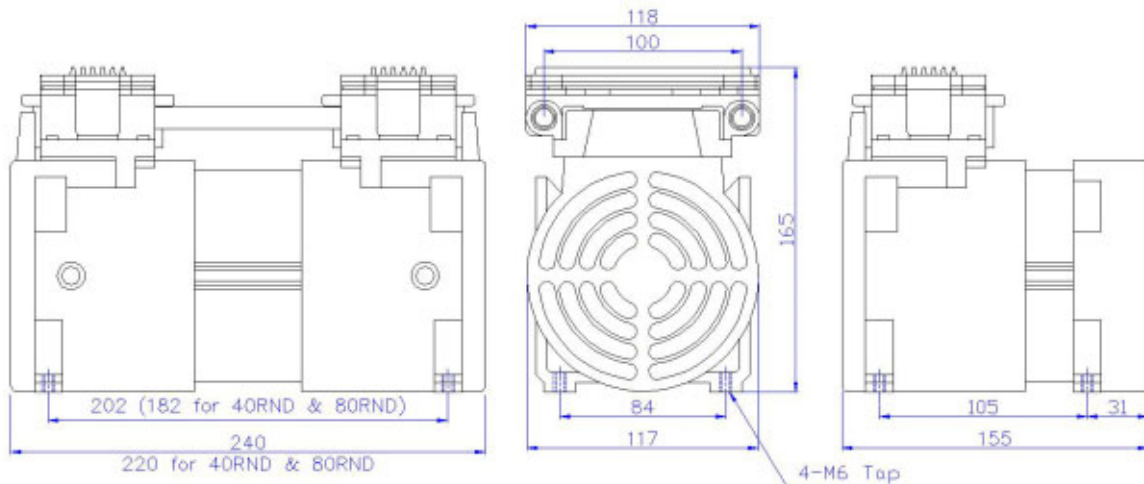

**Double Head / Parallel & Serial connection
PTFE(Teflon) Coated Model**



**Double Head / Parallel connection
Normal Model**



**Single Head
PTFE Coated Model**

Double Head Type

Expert products

■ SPECIFICATIONS

MODEL Descriptions	DOUBLE HEAD							
	140RND	120RND	100RND	80RND	70RVD	60RVD	50RVD	40RVD
HEAD CONNECTING	Parallel Connecting (1-STAGE)				Serial Connecting (2-STAGE)			
HEAD CONFIGURATION	Vacuum / Pressure				Vacuum Only			
FREE FLOW RATE	140 LPM	120 LPM	100 LPM	80 LPM	70 LPM	60 LPM	50 LPM	40 LPM
MAX. VACCUM	700mmHg	690mmHg	680mmHg	650mmHg	750mmHg	745mmHg	740mmHg	720mmHg
MAX.PRESSURE	2 bar	4 bar	7 bar	7 bar	N.A.			
CONNECTING TYPE	R 1 / 4"							
DIMENSIONS	240(L) x 157(H) x 118(W) mm [80RND, 40RVD : 220(L) x 157(H) x 118(W) mm]							
WEIGHT	7.1 kg [80RND, 40RVD : 6.2 kg]							
NOISE LEVEL	55 ~ 58 dB				51 ~ 53 dB			
MOTOR TYPE	Capacitor Start Type, Equipped with Thermal Protector & Inner Cooling Fan							
MOTOR POWER	200 W [80RND, 40RVD : 150W]							
POWER SOURCE	100 ~ 110 VAC (50/60 Hz), 200 ~ 220 VAC (50/60 Hz), 230 ~ 240 VAC (50 Hz)							

■ Performance Curves of Double Head Type

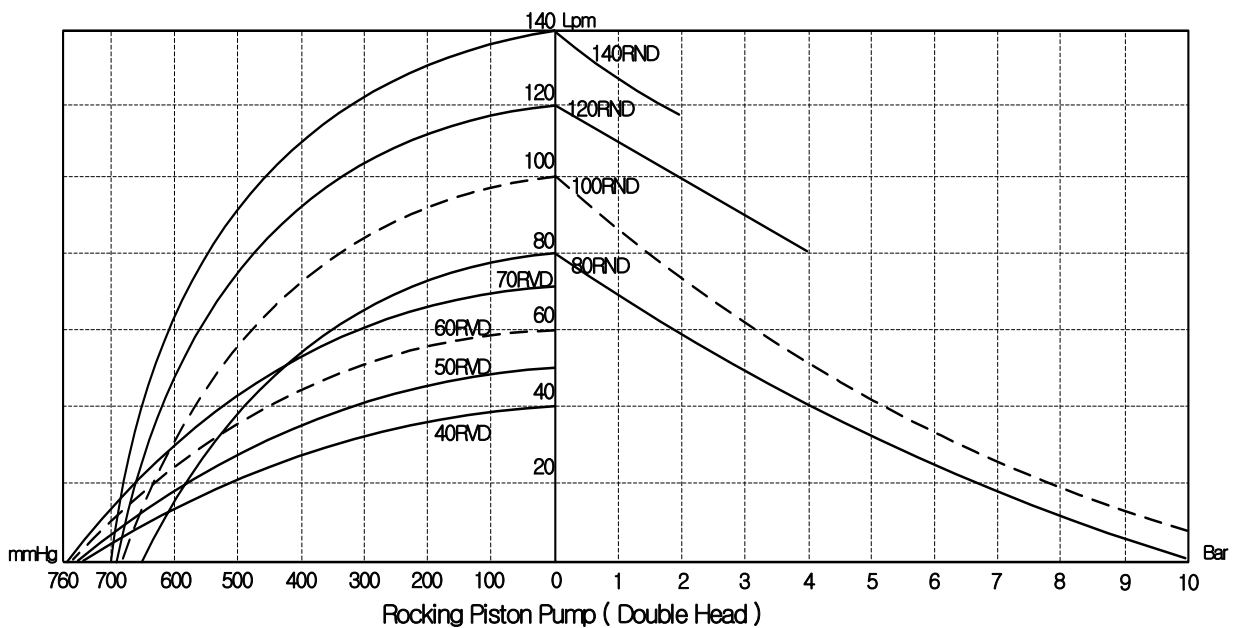

■ SPECIFICATIONS

MODEL Descriptions	SINGLE HEAD			
	70RVS	60RNS	50RNS	40RNS
HEAD CONFIGURATION	Vacuum Only	Vacuum / Pressure		
FREE FLOW RATE	70 LPM	60 LPM	50 LPM	40 LPM
MAX. VACCUM	700mmHg	690mmHg	680mmHg	650mmHg
MAX.PRESSURE	N.A.	2 bar	4 bar	7 bar
CONNECTING TYPE	R 1 / 4"			
DIMENSIONS	155(L) x 157(H) x 118(W) mm / 165(L) x 157(H) x 118(W)			
WEIGHT	4.2 kg / 4.8 kg			
NOISE LEVEL	50 ~ 53 dB			
MOTOR TYPE	Capacitor Start Type, Equipped with Thermal Protector & Inner Cooling Fan			
MOTOR POWER	100 W ~ 150 W			
POWER SOURCE	100 ~ 110 VAC (50/60 Hz), 200 ~ 220 VAC (50/60 Hz), 230 ~ 240 VAC (50 Hz)			

■ Performance Curves of Single Head Type

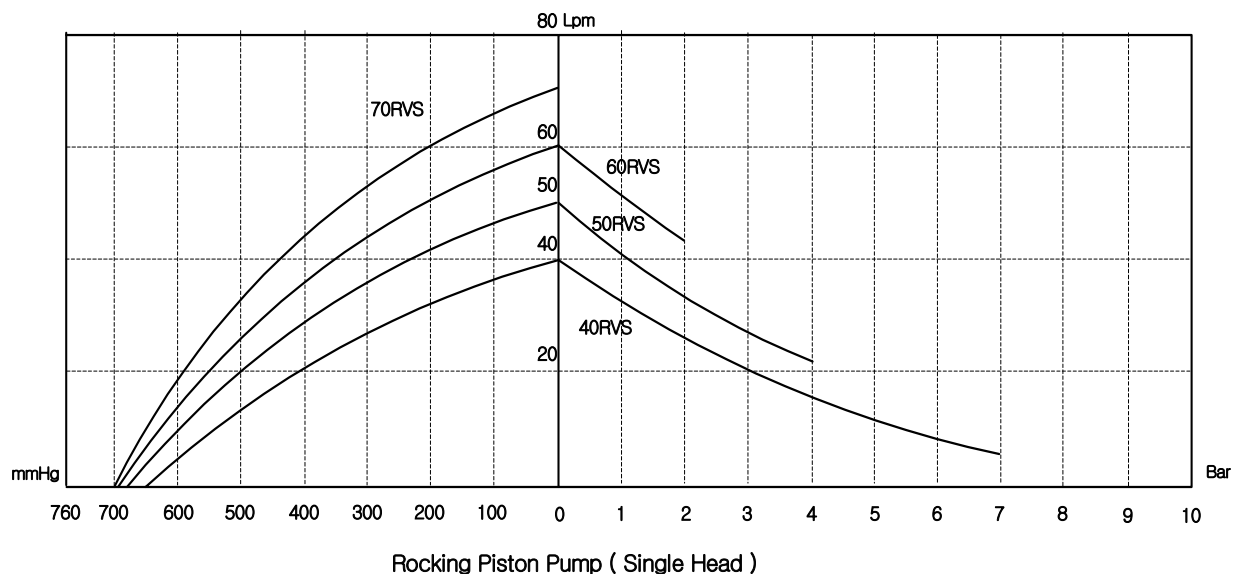

■ Mufflers and filters

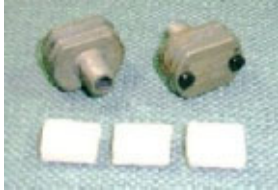

- ◁ AL Die casting body muffler with filters
Provided as a standard accessory.



- ◁ Other material & performance mufflers.
Provided on request..

■ Core parts

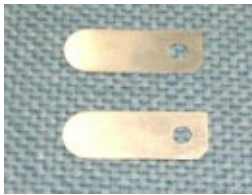

- ◁ Stainless steel valve

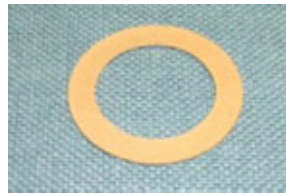

- ◁ Piston Ring (Teflon)



- ◁ Permanently lubricated bearings
6203ZZ for motor shaft
6006ZZ for eccentric



- ◁ 100% of silicon O-rings
We never use gasket made by paper or asbestos



G&M Tech Inc.
[주] 지엔엠텍

2F, #327-7, Dangeong-Dong, Gunpo-City
Kyunggi-Do, Korea
TEL : +82-31-459-8221,
FAX : +82-31-459-8611
Home Page : <http://gnmtechinc.en.ec21.com>
E-MAIL : info@gnmtechinc.com